

MONSTER PARK!

THE VILLAGE CENTRE
RECREATION GROUND
BROADBRIDGE HEATH
PARISH COUNCIL

NEW EQUIPMENT



1. Bespoke Frankenstein's Kooky Castle with Monster Themed Play Panels
Ref PCMT-CUSTOM 700393
Age range 2+ years
DDA Accessible

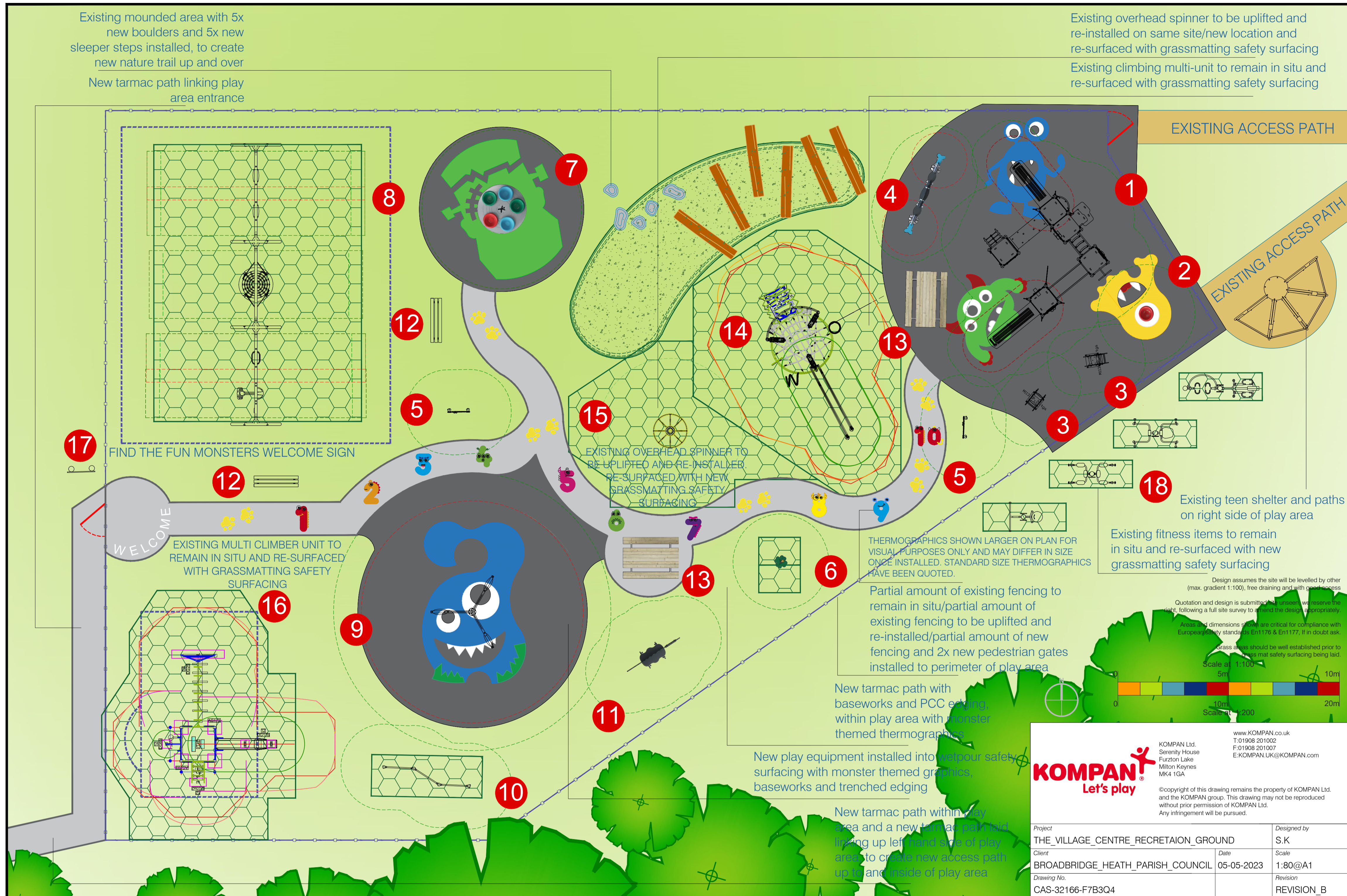

2. Spinner Bowl
Ref ELE400024
Age range 4+ years
DDA Accessible

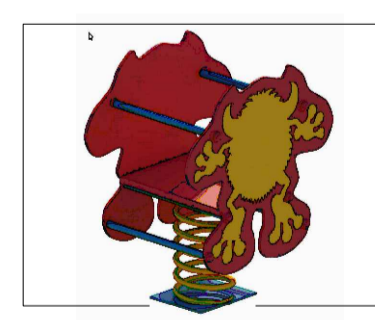

3. Monster Themed Springer x2
(ARTISTIC REPRESENTATION ONLY. FINAL VERSION COULD DIFFER ONCE INSTALLED)
Ref EN-FAHR
Age range 2+ years
DDA Accessible

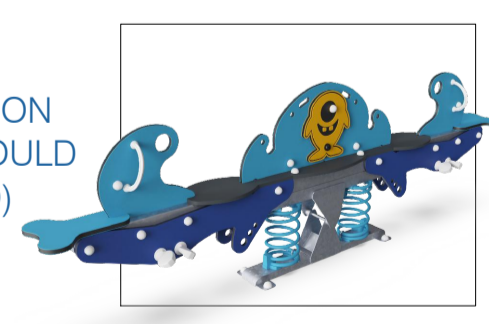

4. 8-Armed Monster Themed Seesaw
Ref MOM-CUSTOM 161583
Age range 3+ years
DDA Accessible



5. Monster Head Through Play Panels x2
Ref EN-FIMONSTER6
Age range N/A
DDA Accessible

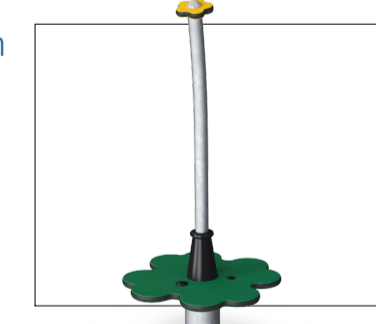

6. Toddler Spica
Ref M191
Age range 1+ years
DDA Accessible



7. Multi-Spinner Carousel
Ref ELE400060
Age range 3+ years
DDA Accessible

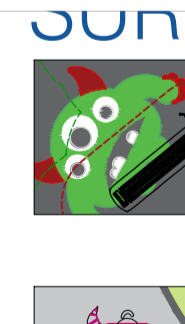

SURFACING.
Black wetpour safety surfacing with "Monster" Themed Graphics

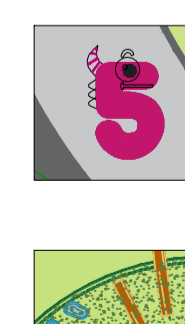

New Tarmac Path with "Monster" Themed Thermographics

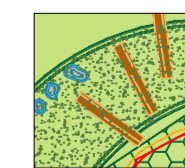

Existing Mound Area

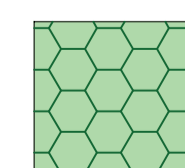

Grassmatting Safety Surfacing

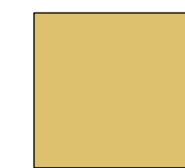

Existing Tarmac Access Paths

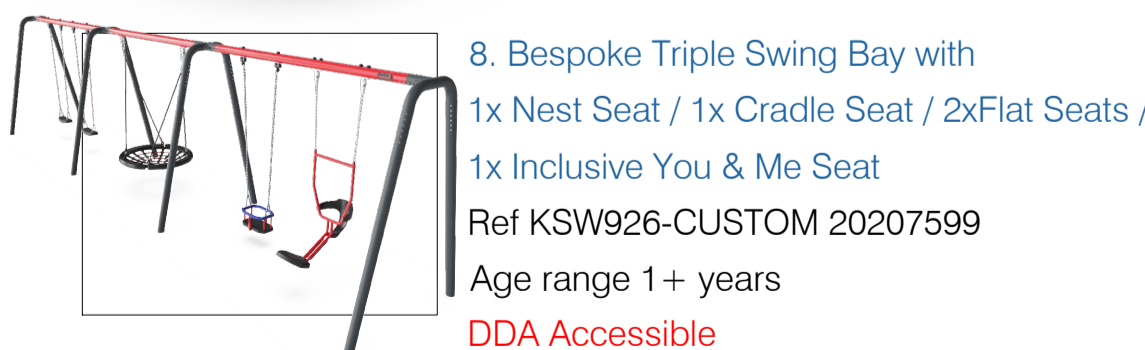

8. Bespoke Triple Swing Bay with 1x Nest Seat / 1x Cradle Seat / 2x Flat Seats / 1x Inclusive You & Me Seat
Ref KSW926-CUSTOM 20207599
Age range 1+ years
DDA Accessible



9. Triple Seat Carousel with 3x Membrane Seats
Ref PCM153-CUSTOM 20207606
Age range 1+ years
DDA Accessible

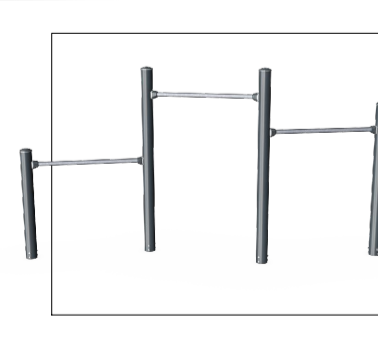

10. Triple Somersault Bars
Ref PCM803
Age range 4+ years
DDA Accessible



11. Crocodile Bench
Ref M24370
Age range 1+ years
DDA Accessible



12. Bench x2
Ref KPL202
Age range N/A
DDA Accessible



13. Picnic Table x2
Ref KPL204
Age range N/A
DDA Accessible

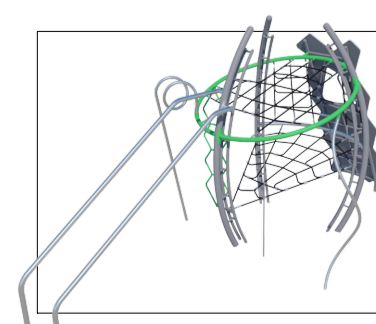

14. Existing Multi-Unit
Ref SMP NEXUS CORE
Age range 6+ years

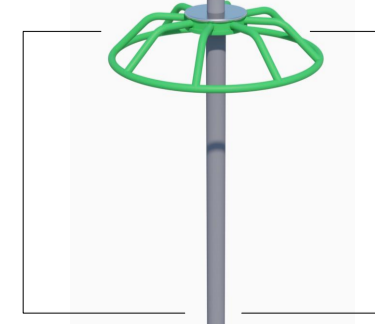

15. Existing Overhead Spinner (TO BE UPLIFTED AND RE-INSTALLED ON SAME SITE)
Ref SMP TORNADO
Age range 6+ years



16. Existing Climber
Ref SMP CLIMBING FRAME
Age range 6+ years



17. Bespoke "WELCOME" Monster Theme Sign
(ARTISTIC REPRESENTATION ONLY. FINAL VERSION COULD DIFFER ONCE INSTALLED)
Ref EN-FALCON-SIGN
Age range N/A
DDA Accessible

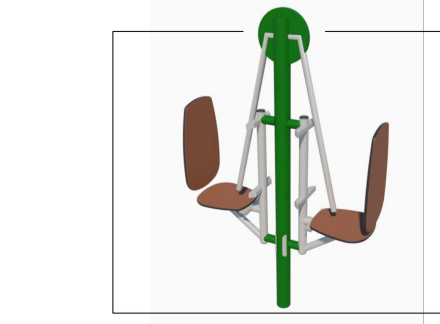

18. Existing Fitness Items (TO REMAIN IN SITU AND BE RE-SURFACED ONLY)
Ref N/A
Age range N/A